

Componentes da porta montada

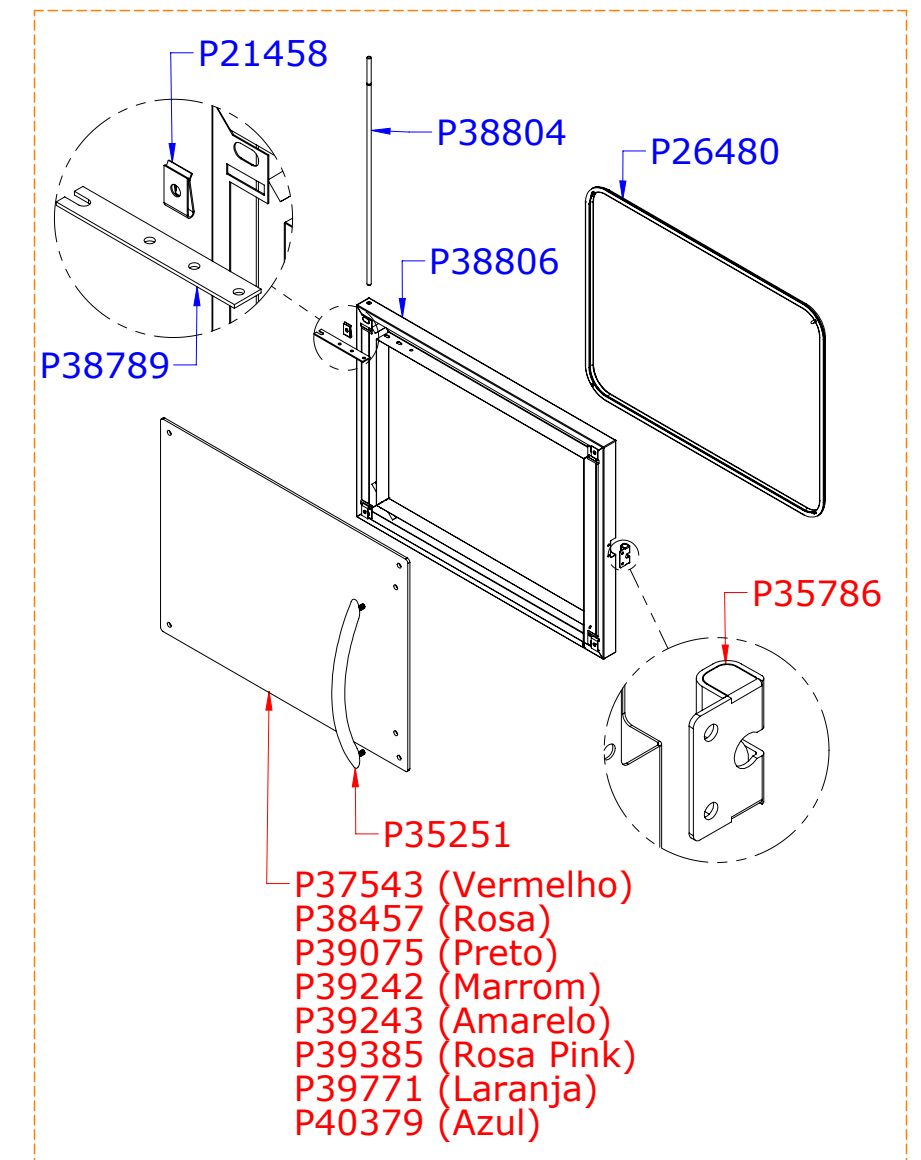

Componentes do painel montado

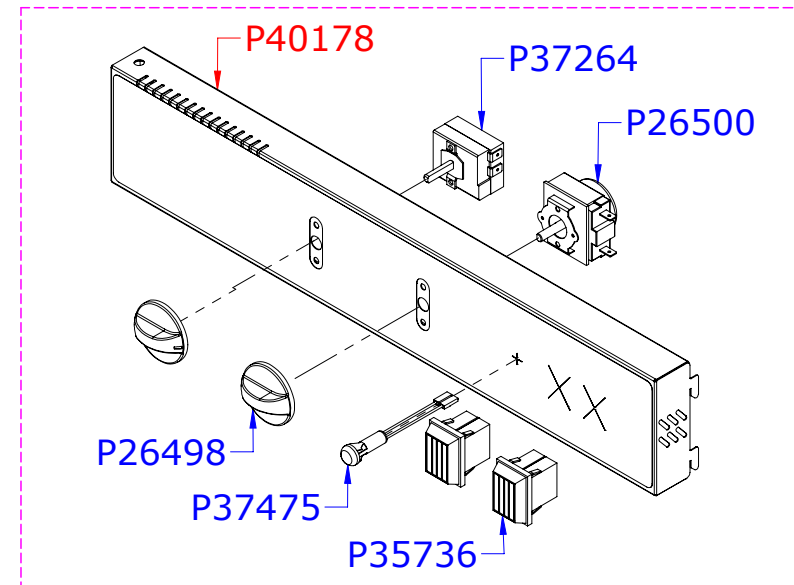

Componentes do conjunto P39441

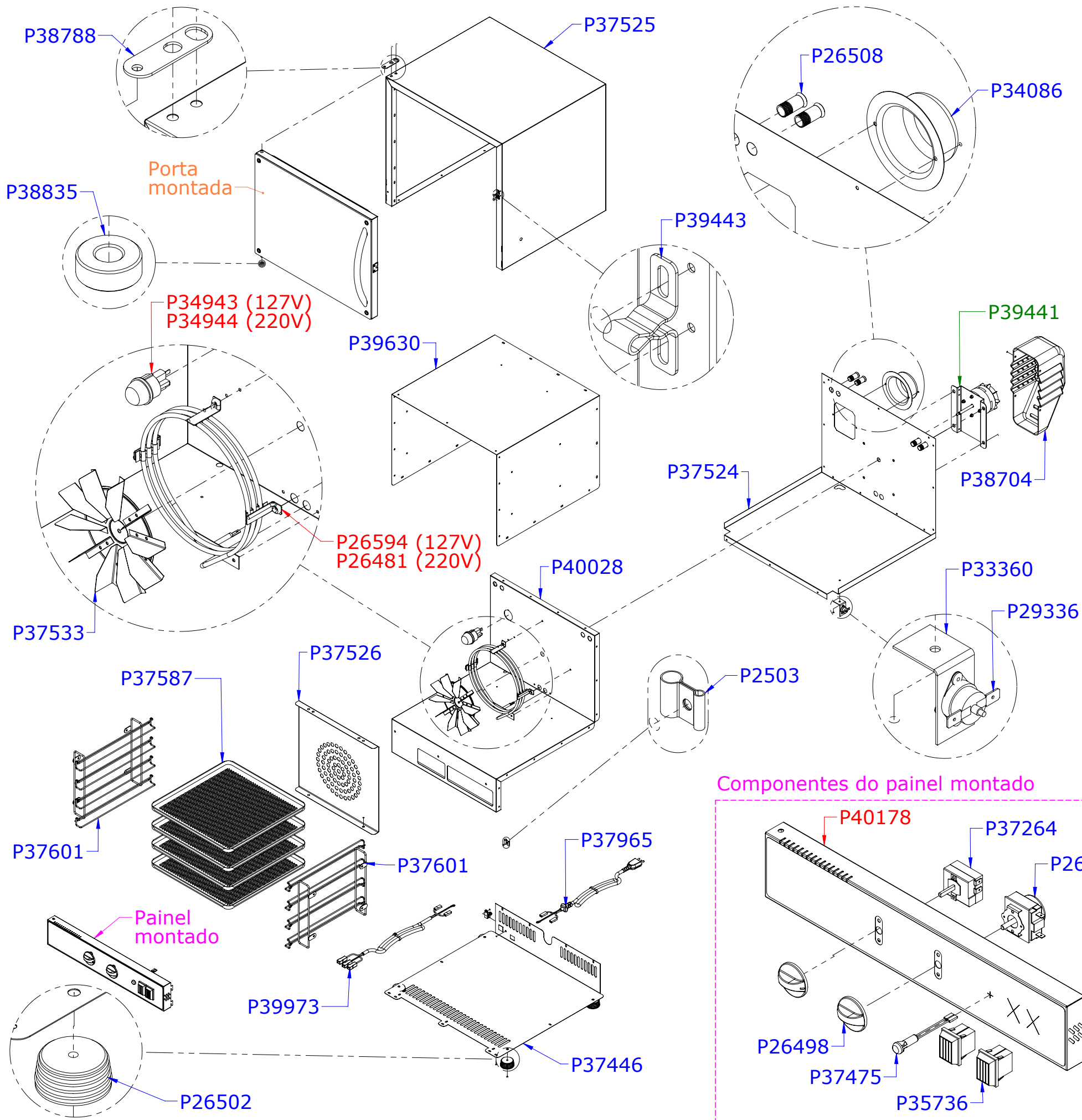
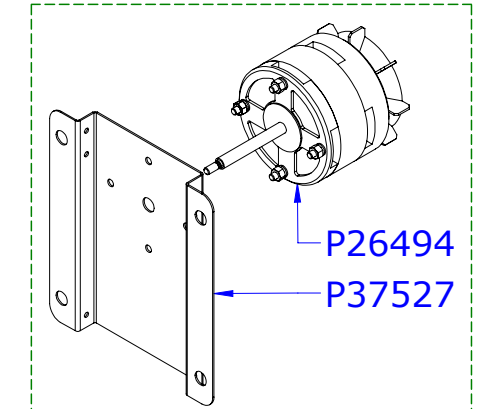

	Produto:	PRP-004 G2
	Data:	04/05/2020