

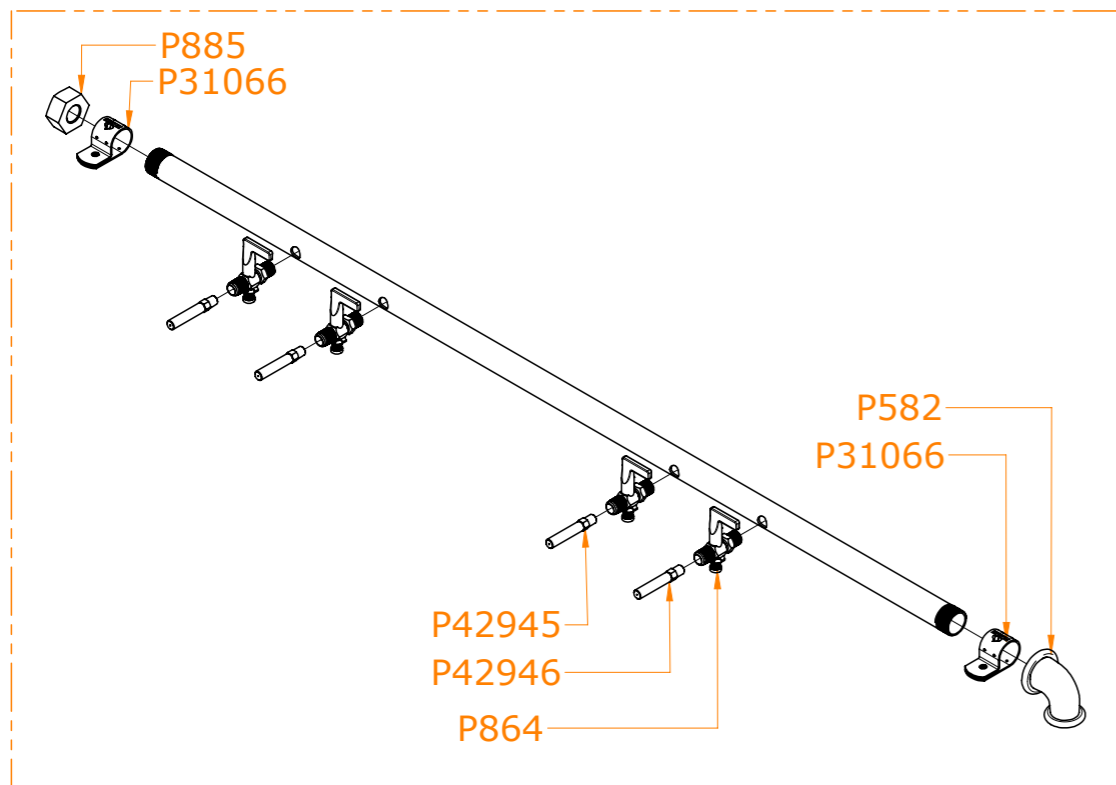

Componentes do conjunto P43061

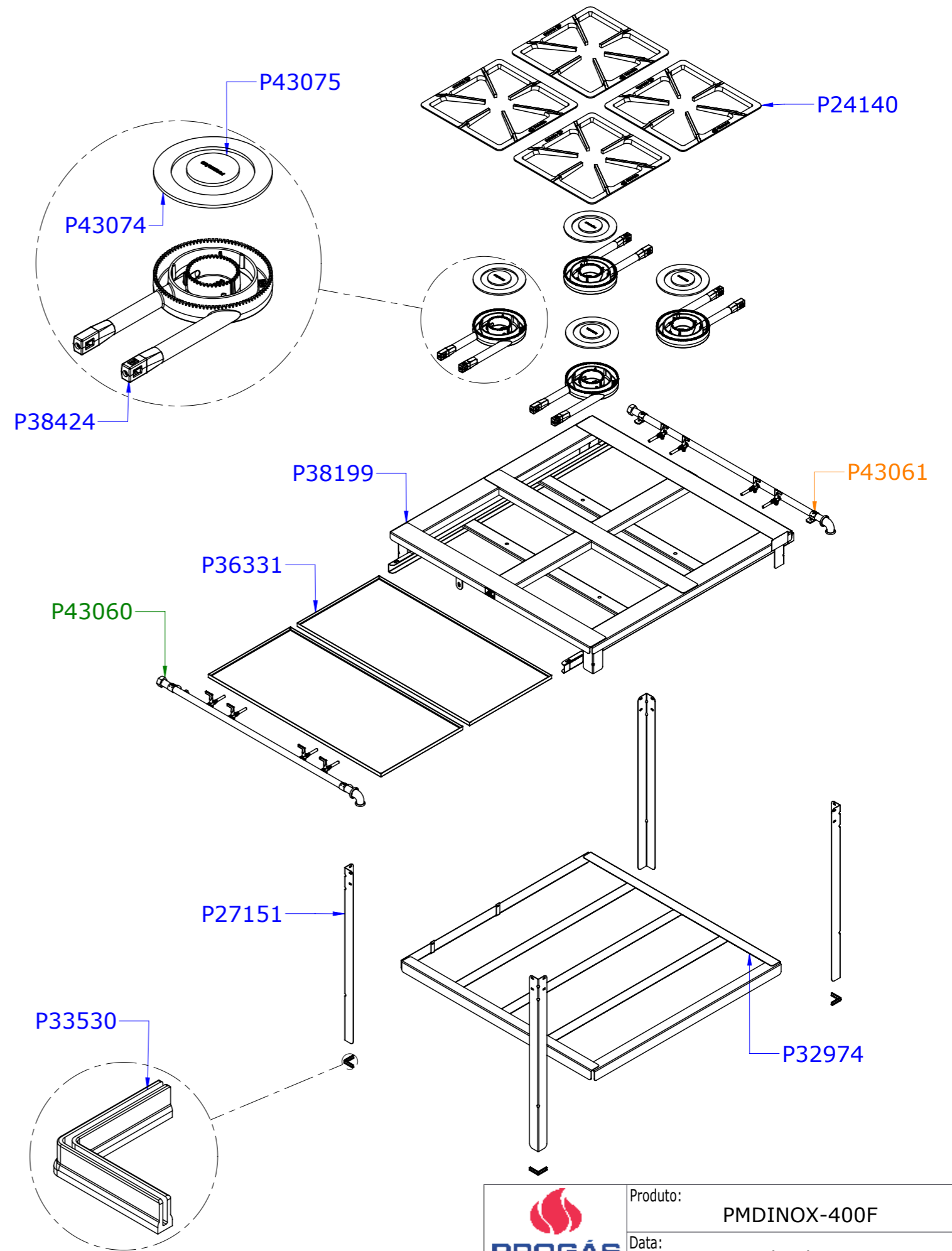

Componentes do conjunto P43060

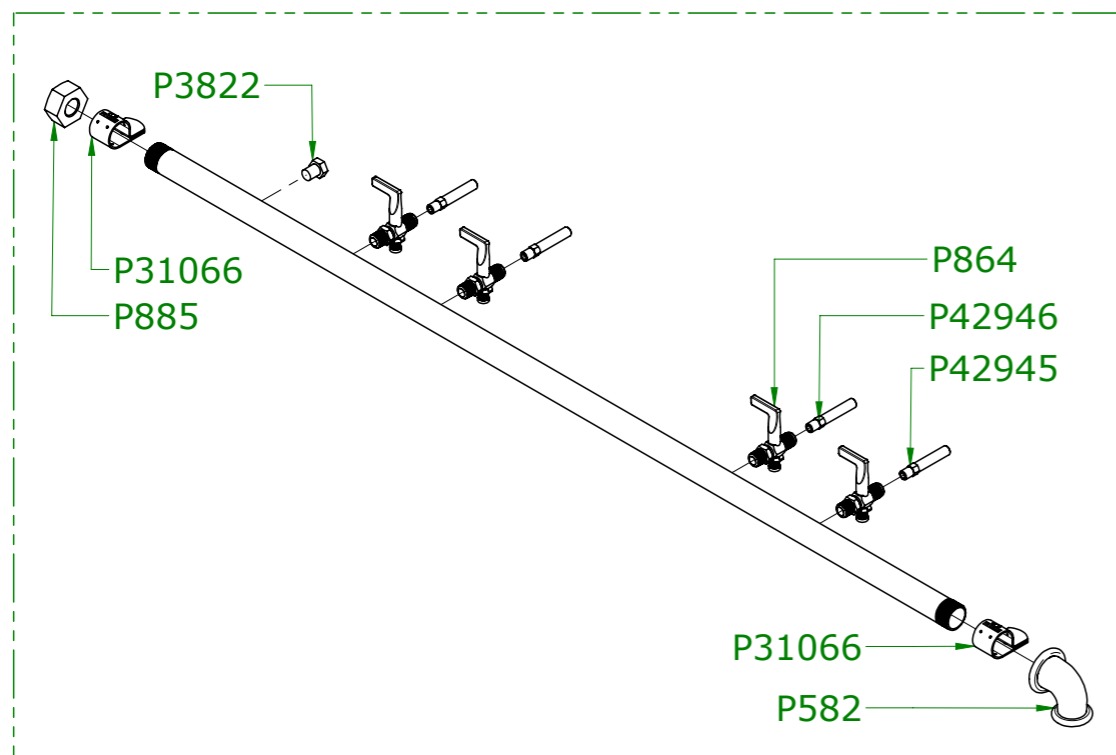

	Produto:	PMDINOX-400F
	Data:	19/12/2022